

SKINDICHT® SHV FKM

SKINDICHT® SHV FKM, watertight PG special sealing cable gland for high temperatures, resistant to oils, acids and chemicals

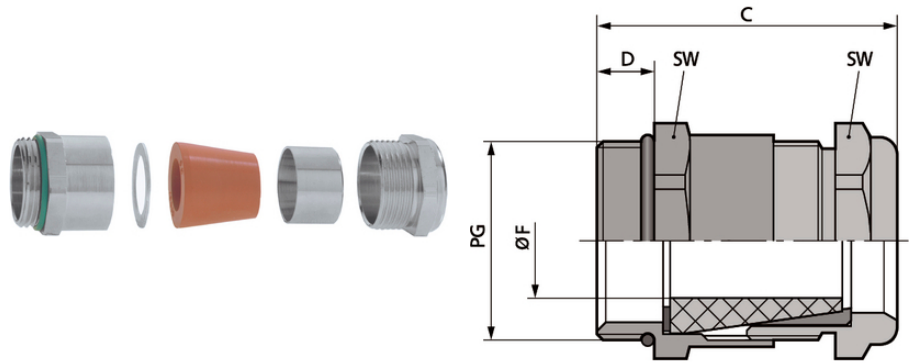

Optimum strain relief



Robust



Temperature-resistant

Benefits

- For high temperatures
- Resistant to oils, solvents, acids and chemicals
- Watertight
- High strain relief
- Robust

Application range

- Watertight and high temperature-resistant cable gland with special conical FKM sealing element
- Brickworks
- Sewage treatment plants
- Car wash sites

Note

- Example order designation:
SHV-FKM 13.5 / 9 / 11
- 13.5 = PG thread of compression screw
- 9 = PG connection thread
- 11 = clear opening of sealing cone

Technical Data

Classification ETIM 5:

ETIM 5.0 Class-ID: EC000441

Last Update (21.12.2023)

©2023 Lapp Group - Technical changes reserved

Product Management www.lappkabel.de

You can find the current technical data in the corresponding data sheet.

PN 0456 / 02_03.16

SKINDICHT® SHV FKM

Classification ETIM 6:	ETIM 5.0 Class-Description: Cable screw gland ETIM 6.0 Class-ID: EC000441 ETIM 6.0 Class-Description: Cable screw gland
Caution:	The installation dimensions can be found in appendix T21
Material:	Body: nickel-plated brass Sealing cone: FKM O-ring: FKM
Protection rating:	IP 68 - 10 bar
Temperature range:	-20°C to +200°C

Note

Photographs and graphics are not to scale and do not represent detailed images of the respective products.
Prices are net prices without VAT and surcharges. Sale to business customers only.

SKINDICHT® SHV FKM

Article number	Article designation / size	Ø F mm	SW wrench size mm	Overall length C mm	Thread length D mm	Pieces / PU
SKINDICHT® SHV FKM						
52024934	SHV-FKM 7/7/5	3.8 - 4.8	14	26.0	5	50
54000015	SHV-FKM 9/9/6	4.8 - 5.8	17	28.5	6	50
52024935	SHV-FKM 9/9/7	5.8 - 6.8	17	28.5	6	50
52024936	SHV-FKM 11/11/7	5.8 - 6.8	20	31.0	6	25
52024937	SHV-FKM 11/11/9	6.8 - 8.8	20	31.0	6	25
52024970	SHV-FKM 13,5/9/11	8.5 - 10.8	22	33.0	6.5	25
52024968	SHV-FKM 13,5/11/9	6.8 - 8.8	22	33.0	6.5	25
52024969	SHV-FKM 13,5/11/11	8.5 - 10.8	22	33.0	6.5	25
52024961	SHV-FKM 13,5/13,5/9	6.8 - 8.8	22	33.0	6.5	25
52024962	SHV-FKM 13,5/13,5/11	8.5 - 10.8	22	33.0	6.5	25
52024971	SHV-FKM 16/11/13	10.8 - 12.8	24	35.0	6.5	25
52024973	SHV-FKM 16/13,5/13	10.8 - 12.8	24	35.0	6.5	25
52024964	SHV-FKM 16/16/13	10.8 - 12.8	24	35.0	6.5	25
52024965	SHV-FKM 16/16/15	13.8 - 14.8	24	35.0	6.5	25
52024966	SHV-FKM 21/21/18	15.8 - 17.8	30	38.0	7	25
52024967	SHV-FKM 21/21/20	17.5 - 19.8	30	38.0	7	25
52024974	SHV-FKM 29/29/22	19.5 - 21.8	40	44.5	8	10

Last Update (21.12.2023)

©2023 Lapp Group - Technical changes reserved

 Product Management www.lappkabel.de

You can find the current technical data in the corresponding data sheet.

PN 0456 / 02_03_16